

# IP-Mole IP 95 Z

- 101. threaded anvil
- 2. casing
- 3. piston
- 4. control valve
- 401. control valve tube
- 402. control sleeve
- 403. control valve rubber

- 6. outer support sleeve
- 7. shock absorber
- 8. flap valve
- 10. spring
- 1001. spacer for spring
- 12. circlip
- 14. endnut

- 15. tail hose nut
- 16. tail hose with couplings
- 17. cutting head
- 18. locking nut
- 19. protection nut
- 22. collets
- 330. spanner

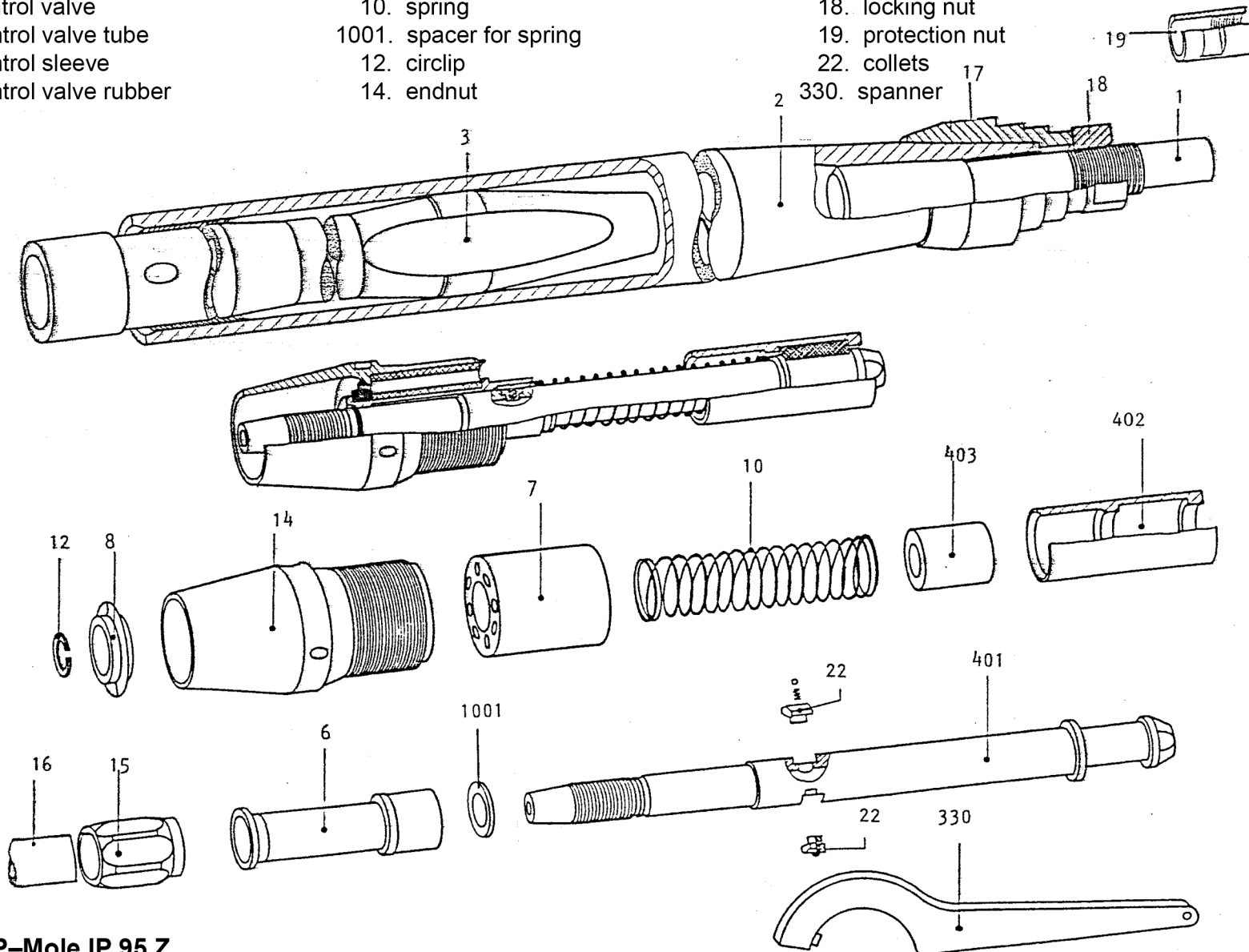

## Essig IP-Mole IP 95 Z

Made in Germany by Fa. H. Jürgen Essig, Industrielle Anlagen GmbH & Co. KG • Gänsekamp 35 • 32457 Porta-Westfalica • Fon - 49 - 5 71 - 7 20 90